

**SANMOTION**

**CLOSED LOOP STEPPING SYSTEM**

**Model No.PB**

**PCIF Software**

SPBALL-01

For PB4A

**Instruction Manual**

## ■ Preface

This product in this instruction manual corresponds with the shipping regulations given in the Export Trade Control Ordinance (Table 1, item 16). When these products are exported by customers, it is recommended to fulfill the requirements of export procedure with the relevant authorities, as well as “Information Requirements” and “Objective Requirements” according to the Catch-all regulations.

This instruction manual describes the method of use and precautions about the PCIF software; SPBALL-01 for the amplifier model number: PB4A002\*30\*. Refer to the amplifier instructions manual for the function of amplifier, precautions, etc.

PB4A002P30\*: M0008374

PB4A002R30\*: M0008431

## ■ Disclaimers

- Reproduction or transfer of this software or manual, in whole or in part, is strictly prohibited without written permission.
- This software was prepared and distributed for the purpose of assisting system startup. Sanyo Denki shall not be liable for any problems or damage that occurs in the course of using this software.
- Refer to the installation manual or homepage enclosed by the product for driver installation of Uport 1130, and the details of the method for use. (<http://www.moxa.com/>)
- The fault resulting from Uport 1130 takes no responsibility in our company. Please understand it previously.

## ■ Notifications on this User's Manual:

- Read this manual carefully before use to ensure proper operation.
- Contact the head office or our sales departments listed on the back cover if there is incorrect collating or missing page
- Make sure to follow the directions on safety cautions in this manual. We will not insure safety in the use other than specified in this manual or in the improper use.
- This manual content may be revised without notice because of product version up or usage additions. The changes will be noticed by revising this manual.
- Some figures in this manual may be outlined or abstract.
- Contact the head office or our sales departments listed on the back cover in case of questions or omission.

# Contents

<b>Chapter 1 Safety</b>	
1.1 Meaning of Warning Indications.....	1-1
1.2 Safety Precautions.....	1-2
<b>Chapter 2 Unpacking</b>	
2.1 Package Checklist .....	2-1
2.2 Confirmation of the Product .....	2-1
<b>Chapter 3 Installation</b>	
3.1 Driver Installation .....	3-1
3.2 Hardware Installation .....	3-3
3.3 Communication Specification (Half/Full-duplex) Setup .....	3-5
3.4 Software for setup Installation .....	3-7
<b>Chapter 4 Connection</b>	
4.1 Cable Assemble .....	4-1
4.2 Connections .....	4-3
4.3 Limitations at Operating Communication .....	4-4
<b>Chapter 5 Basic Operation</b>	
5.1 Start-up .....	5-1
5.2 Main Display .....	5-3
5.3 Menu Bar/Tool Bar .....	5-4
5.4 Mode Selection Button .....	5-5
5.5 Monitor .....	5-6
5.6 Unit System .....	5-7
<b>Chapter 6 Direct Mode</b>	
6.1 Direct Display .....	6-1
6.2 Operation Procedure .....	6-2
6.3 Direct Command Input .....	6-3
<b>Chapter 7 Point Edit Mode</b>	
7.1 Point Edit Display .....	7-1
7.2 Point Edit Method .....	7-2
7.3 Teaching .....	7-4
<b>Chapter 8 Program Edit Mode</b>	
8.1 Program Edit Display .....	8-1
8.2 Program Edit Method .....	8-2
8.3 Program Execution .....	8-4
8.4 Sample Program .....	8-5
<b>Chapter 9 Waveform Trace</b>	
9.1 Waveform Trace Display .....	9-1
9.2 Waveform Trace Operation Procedure .....	9-2
9.3 Measures .....	9-4
9.4 Motor Starting-up during Waveform Trace .....	9-5

# 1. Safety





---

## 1. Safety









### 1.1. Meaning of Warning Indications

This documentation uses the following annotation. Make sure to strictly follow these safety precautions.

■ There are four precaution levels.

 <b>Danger</b>	Denotes immediate hazards which WILL probably cause severe bodily injury or death as a result of incorrect operation.
 <b>Caution</b>	Denotes hazards which COULD cause bodily injury and product or property damage as a result of incorrect operation. *Even those hazards denoted by this symbol could lead to a serious accident.
 <b>Prohibited</b>	Indicates actions that must be carried out (mandatory actions).
 <b>Mandatory</b>	Indicates actions that must not be allowed to occur prohibited actions.

■ There are eight graphic symbols.

Type	Sample symbols		
Danger symbols	 Danger /Injury	 Electric shock	
Caution symbols	 Caution	 Fire	 Burn
Prohibition symbols	 Prohibited	 Disassembly prohibited	
Mandatory symbol	 Mandatory		

# 1. Safety

---

## 1.2. Safety Precautions



### Danger

#### “General”

1. Do not use this device in explosive environment.  
Injury or fire could otherwise result.
2. Do not perform any wiring, maintenance or inspection when the device is hot-wired. After switching the power off, wait at least 1 minutes before performing these tasks. Damage to the motor /amplifier or Electric shock could otherwise result.
3. Only technically qualified personnel should transport, install, wire, operate, or perform maintenance and inspection on this device.  
Electric shock, injury or fire could otherwise result.

#### “Wiring”

4. The USB terminal and RS-485/422 terminal are not insulated.  
When grounding the positive side power supply of amplifier, do not connect with the equipment (PC, etc.) that grounded the negative side, and with the equipment that grounded 24V.  
Short circuit, injury, damage or fire could otherwise result.
5. Do not damage the cable, and not apply unreasonable stress to it, and not place heavy items on it, and not insert it in between objects.

#### “Operation”

6. Do not touch or get close to the terminal while the device is powered up. Electric shock could otherwise result.
7. Do not unplug the connector while the device is powered up or before one (1) minute has elapsed after power shutdown. Damage to the motor /amplifier or Electric shock could otherwise result.



### Caution

#### “General”

1. Please read the User Manual carefully before installation, operation, maintenance or inspection, and perform these tasks according to the instructions. Electric shock, injury or fire could otherwise result.
2. Do not measure the insulation resistance and the pressure resistance. Damage to the device could otherwise result.
3. Do not subject the device to excessive shock or vibration. Damage to the device could otherwise result.

#### “Installation”

4. Keep the terminals away from static electricity. Damage to the device could otherwise result.
5. Do not stand on the device or place heavy objects on top of it. Bodily injury could otherwise result.
6. Do not expose the device to water, corrosive or flammable gases, or any flammable material. Fire or damage to the device could otherwise result.

## 1. Safety

---



### Prohibited

#### “Storage”

1. Do not store the device where it could be exposed to rain, water, toxic gases or other liquids. Damage to the device could otherwise result.

#### “Maintenance”

2. Do not overhaul the device. Fire or electric shock could otherwise result.

#### “General”

3. Do not remove the nameplate cover attached to the device.



### Mandatory

#### “Storage”

1. Store the device where it is not exposed to direct sunlight, and within the specified temperature and humidity ranges {-20°C to +65°C, below 90% RH (non-condensing)}.

#### “Operation”

2. Operate within the specified temperature and humidity range {Temperature 0°C to 55°C, Humidity below 90% RH (non-condensing)}.

#### “Transport”

3. Follow the directions written on the outside box. Excess stacking could result in collapse.

## 2. Unpacking

---

### 2. Unpacking

#### 2.1 Package Checklist

Before installing the adaptor, please verify that the package contains the following items:

- |  |   |
|--|---|
| · Converter (UPort 1130)                                     | 1 |
| · CD-ROM (The document of the converter and driver software) | 1 |
| · Terminal block conversion adaptor                          | 1 |
| · Communication cable (PBC6T0005A)                           | 1 |

Please notify the head office or our sales departments listed on the back cover if any of the above items are missing or damaged.

#### 2.1. Confirmation of the Product

Verify the followings after receiving the product. If you find any discrepancy, contact your distributor or sales office.

- Verify that the model number is the same one as ordered.
- Verify that there are no abnormalities, such as damages to the appearance of the device, or missing accessories.

## 3. Installation

---

### 3. Installation

The procedure of using this converter for the first time is described below.

#### Note

Before plugging the adaptor into your computer's USB port, we recommend installing the driver first.

#### 3.1. Driver Installation (MOXA® Uport1130 Driver Installation)

- i. Start-up the Windows, and insert the CD-ROM into your drive.
- ii. Start-up [driv\_win\_uport1p\_v1.5\_build\_07122513.exe] in the folder of [UPort 1110\_1130]-[Software].  
\*A file name may be changed by upgrade of a driver.
- iii. Click [Next].

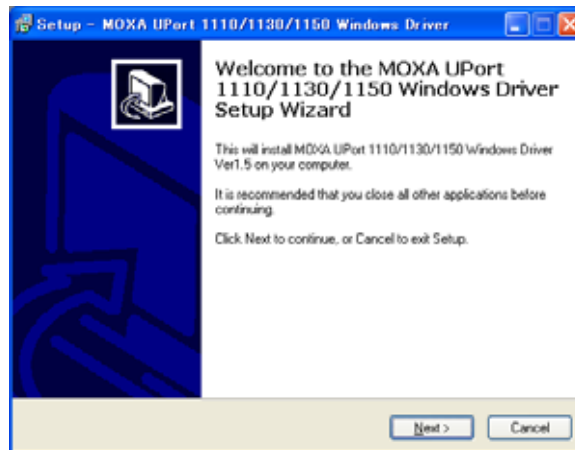

- iv. Click on [Next] to install the driver in the indicated folder.

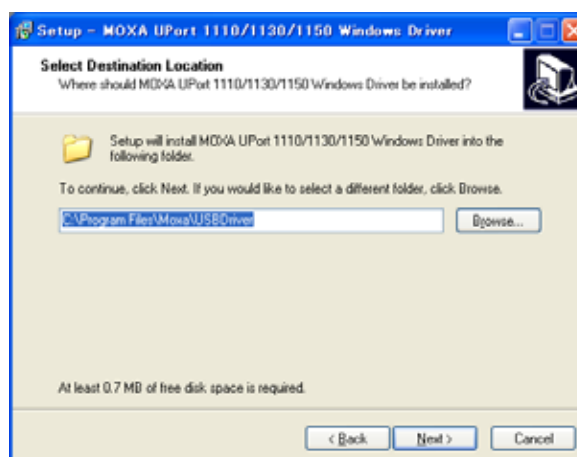

### 3. Installation

- v. Click on [Install] to proceed with installation.

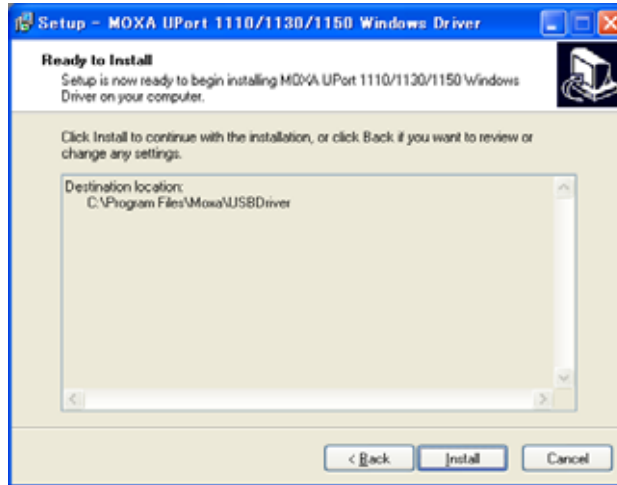

- vi. The next window cautions you that this software has not passed Windows logo testing. This is a standard warning, and Moxa has thoroughly tested the driver for safe Windows operation. Please click [Continue Anyway] to proceed.

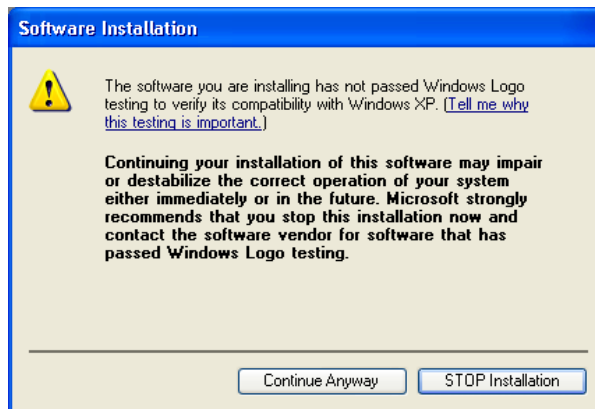

- vii. Click [Finish].

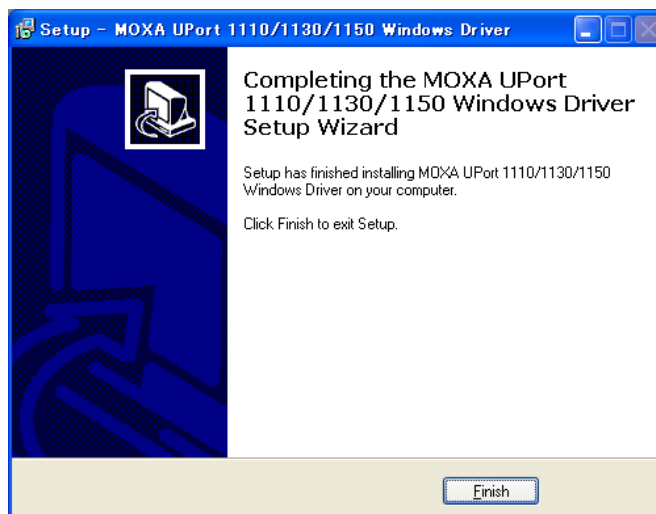

## 3. Installation

### 3.2. Hardware Installation

- i. Plug the adaptor into a USB port on your computer.
- ii. Select [Install the software automatically (Recommended)], and then click [Next ]to proceed.



- iii. The next window cautions you that this software has not passed Windows logo testing. This is a standard warning, and Moxa has thoroughly tested the driver for safe Windows operation. Please click [Continue Anyway] to proceed.



- iv. Click [Finish].  
Then, start installing the Port Driver.



### 3. Installation

- v. Select [Install the software automatically (Recommended)], and then click [Next] to proceed.



- vi. The next window cautions you that this software has not passed Windows logo testing. This is a standard warning, and Moxa has thoroughly tested the driver for safe Windows operation. Please click [Continue Anyway] to proceed.



- vii. Click [Finish].

Now, installation is completed.

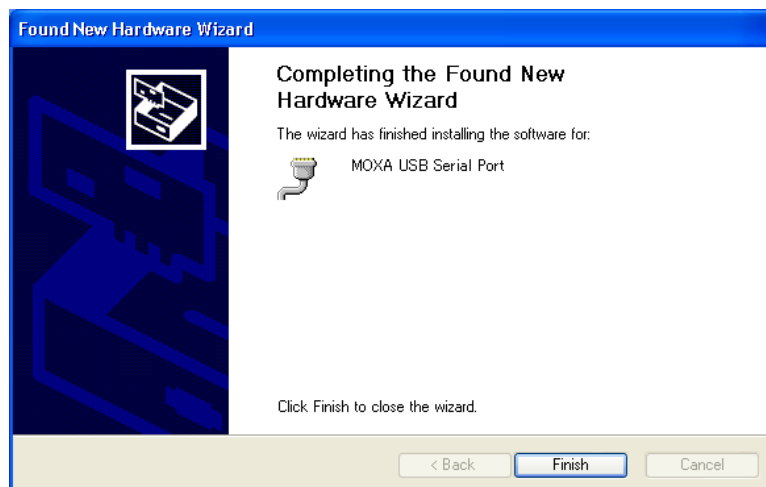

## 3. Installation

### 3.3. Communication Specification (Half/Full-duplex) Setup

An adapter is set up according to the communication specification (Half/Full-duplex) of the amplifier to connect.

\*Amplifier model No. "PB4A002\*30\*" is half-duplex.

- i. Open the Device Manager.
- ii. Double-click [Multi-port serial adapters]-[UPort 1130].

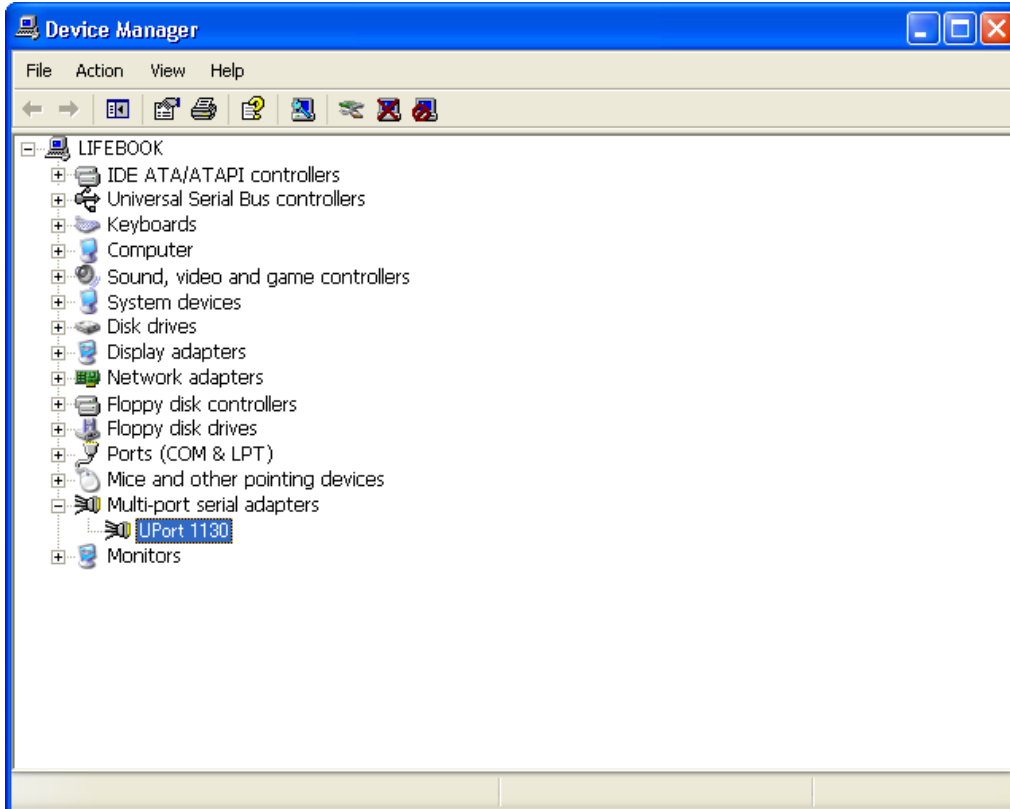

- iii. Click [Port Setting] on the [Port Configuration] tab.

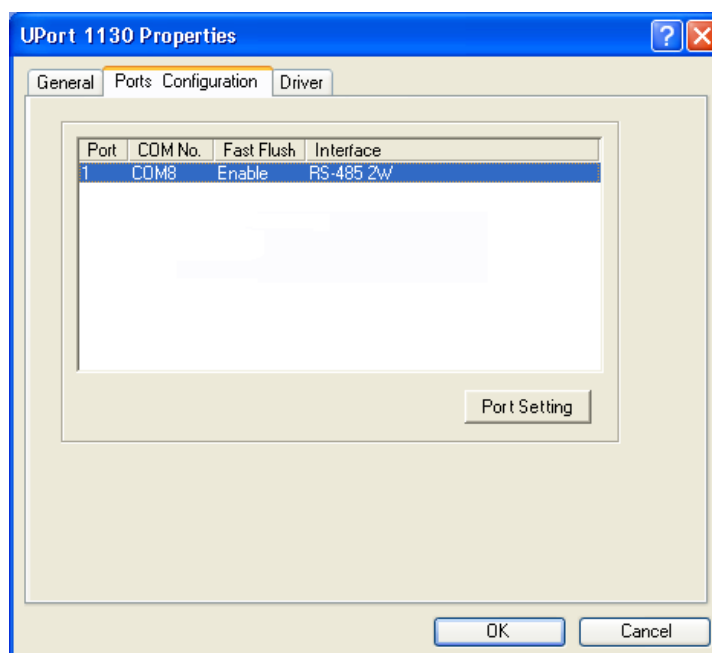

### 3. Installation

---

- iv. Select [Interface] setup with the communication specification of amplifier as follows, then click [OK].  
Full-duplex: [RS-485 4W]  
Half-duplex: [RS-485 2W]

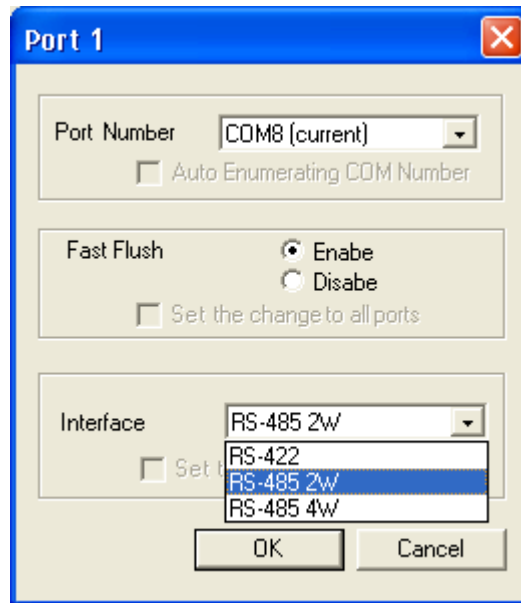

#### [Important]

Please refer to the Installation manual or Home Page (<http://www.moxa.com/>) enclosed in the packing for the details of driver installation and methods of use of Uport 1130.

Please understand previously that any errors caused by Uport 1130 are not our responsibility.

## 3. Installation

---

### 3.4. Software for setup Installation

Install the “SPBALL-01.”

In order to perform this software, .NET Framework 2.0 is required. If .NET Framework 2.0 is not installed in the personal computer to be used, .NET Framework 2.0 should be installed at the first.

- i. Execute the Setup.exe.  
If .NET Framework 2.0 is Not installed, go on to ii.  
If it Is installed, go on to iii.
- ii. Click [Accept] to start the installation of .NET Framework 2.0.

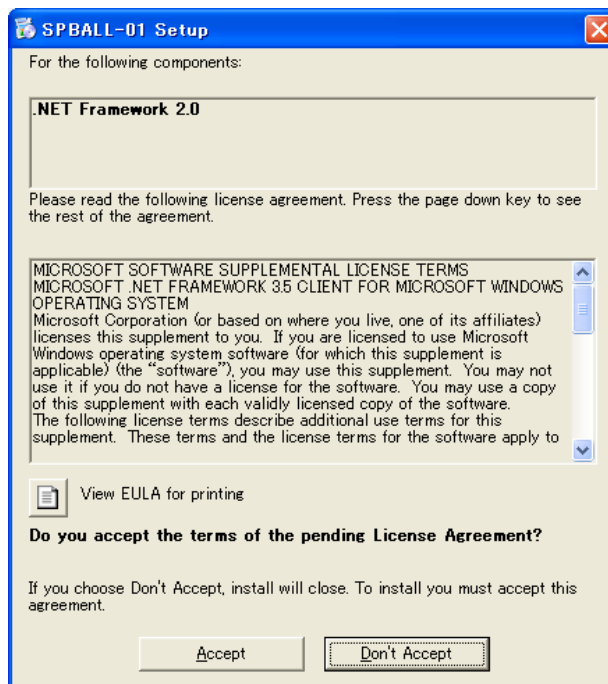

- iii. Click [NEXT].

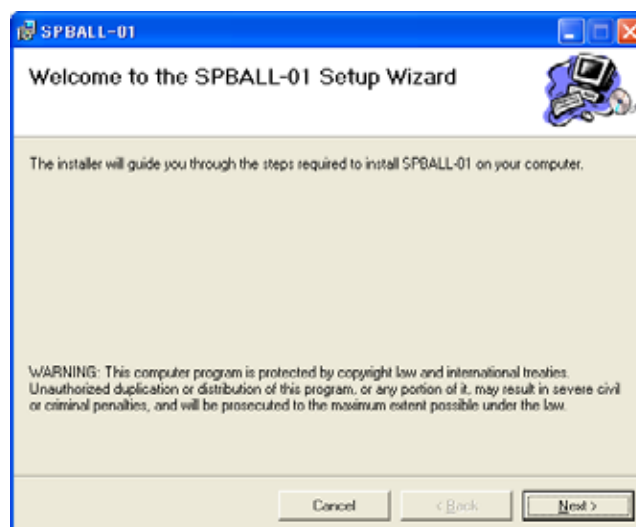

### 3. Installation

---

- iv. Select the installation folder and the user, then click [Next].

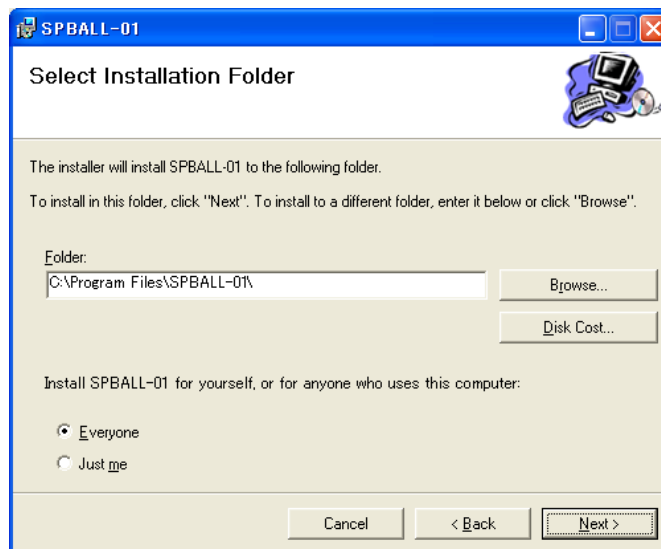

- v. Click [Next] to start the installation.

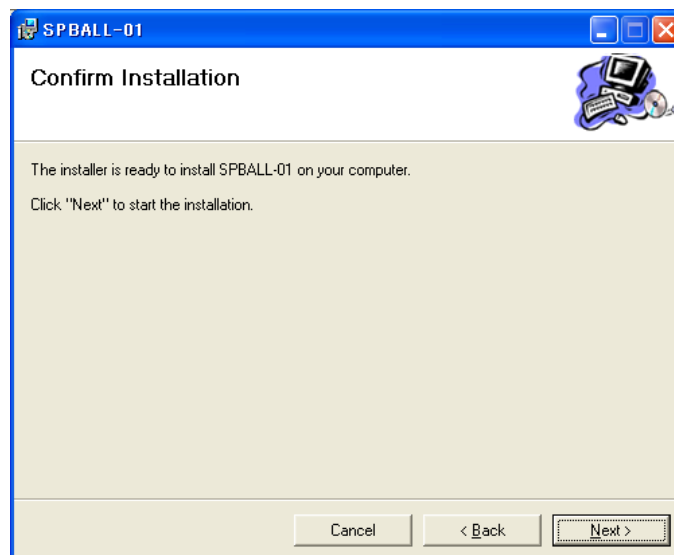

- vi. Click [Close] to complete the installation of the software "SPBALL-01".

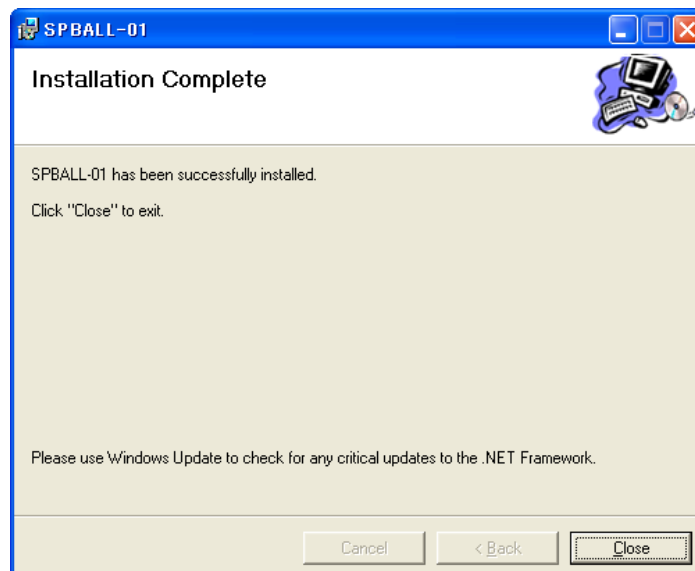

## 4. Connection

### 4. Connection

#### 4.1. Cable Assemble

Perform wire connection of a communication cable and a connector terminal block.

Wire connection differs by half-duplex and full-duplex. Please do wire connection with the communication specification of the amplifier to connect as follows.

#### ■ Half-duplex

Amplifier Model No.

PB2D003R1U0

PB2D003R1U1

PB3D003M200

PB4A002R300

PB4A002R301

PB4A002P300

PB4A002P301

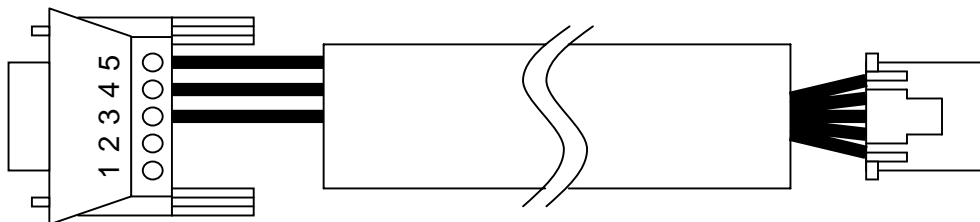

Cable wiring table

Terminal Block		Communication cable
Pin No.	Signal name	
1	T+	N.C.
2	T-	N.C.
3	R+(D+)	YELLOW
4	R-(D-)	WHITE
5	GND	BLACK

#### [Important]

PB4A002R30\* has two Communication port systems; COM1 and COM2.

When connecting COM2, wire as the following.

When connecting COM2 (115200bps)

Terminal Block		Communication cable
Pin No.	Signal name	
1	T+	N.C.
2	T-	N.C.
3	DATA+(A)	BROWN
4	DATA-(B)	BLUE
5	GND	BLACK

## 4. Connection

---

### ■ Full-duplex

Amplifier Model No.

PB2D003R1U2

PB2D003R1U3

PB3A003R200

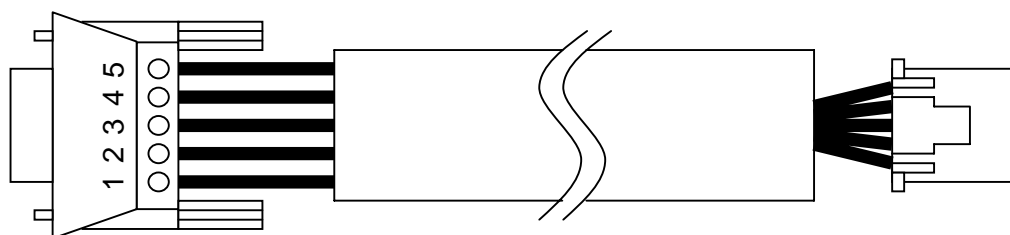

Cable wiring table

Terminal Block		Communication cable
Pin No.	Signal name	
1	T+	BROWN
2	T-	BLUE
3	R+(D+)	YELLOW
4	R-(D-)	WHITE
5	GND	BLACK

## 4. Connection

### 4.2. Connection

Please use the cable made by the 4.1st clause and connect PB amplifier with your personal computer as the following figures.

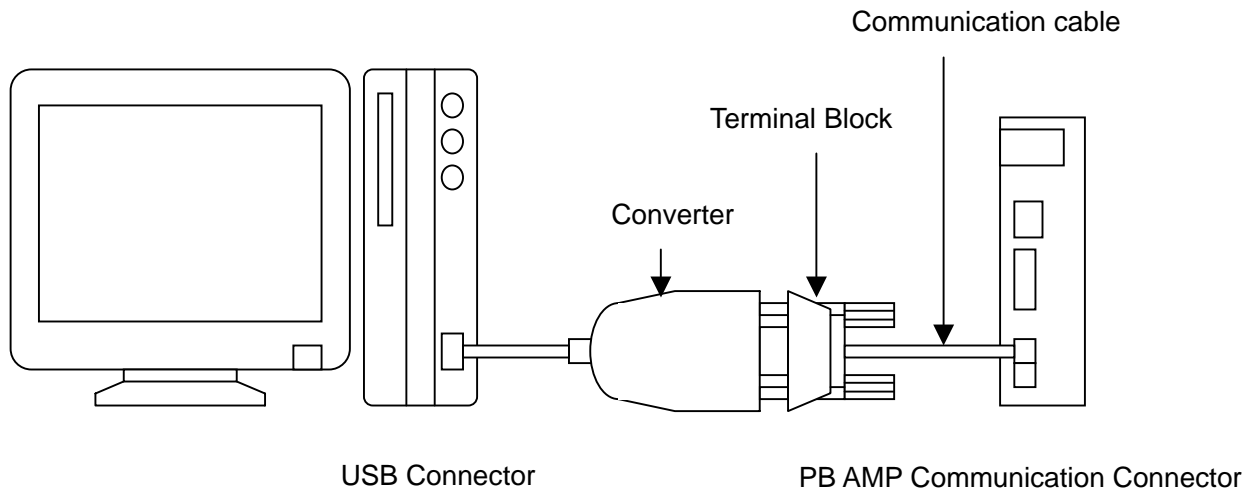

## DANGER

The USB terminal of the communication converter and RS-485 terminal are not insulated.

When connecting with your personal computer, do not ground FG of its personal computer. Short circuit, injury, damage or fire could otherwise result.

### [Important]

USB/RS-485 conversion unit: PBFM-U6 can be used for the following models. However, keep in mind that the PCIF software differs from what applies depending on the amplifier model.

This specifications describes the instruction for the PCIF software of the amplifier model number: PB4A002\*30\*.

Amplifier Model No.	Applied PCIF Software	Communication Spec
PB4A002*30*	SPBALL-01	RS-485 Half-duplex
PB3A003R200	SPBA1W-01	RS-485 Full-duplex
PB3D003M20*	SPBA1W-01	RS-485 Half-duplex
PB2D003R1U0, 1	SPBD2W-01	RS-485 Half-duplex
PB2D003R1U2, 3	SPBD2W-01	RS-485 Full-duplex

## 4. Connection

---

### 4.3 Limitations at Operating Communication

In usage of PCIF, limitations are described below.

- 1) SPBALL-01 can not perform a setup with communication speed of 307200bps. In usage of 307200bps, please set up by the Digital Operator. Refer to the amplifier instruction manual "M0008431" for the details of the setting method.
- 2) When communication speed is changed by PCIF, the communication after change becomes impossible. Therefore reboot after ending PCIF once with the communication speed that made a setting change. Besides, when saving the communication speed changed after the reboot, please save the parameters.
- 3) When operating communication of [File->PC] or [File->AMP], please set previously the communication speed saved in Parameter File as amplifier to be used.

# 5. Basic Operation

## 5. Basic Operation

### 5.1. Start-up



Select the model number of the amplifier and motor to be used from lists.

As for AMP Type, Rev and a display language are added to the end. A display language indicates J=Japanese and E=English. The target displays are only a command name and an explanatory note. In other than Japanese, the display of Menu etc. will be an English display depending on the linguistic environment of OS.

## Caution

Amplifier and motor may be damaged when Motor Type is different from the motor to be used.

Please be sure to set up before motor connection.

Click [ON LINE] when communicating by connecting with amplifier. In contrast, click [OFF LINE] when you perform an inspection and edit of a data file without connecting with amplifier.



As for [ON LINE], set up a communications protocol.

Set up an amplifier address, a COM port number, and communication speed, respectively, then click [NEXT].

The following messages are indicated when the motor used differs from the initial value of the motor cord set up at the time of factory shipments.

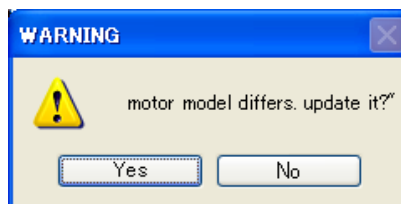

Click [Yes] and change a motor cord into the motor to be used. The taskbar under data reading is indicated and the main display will be appeared after reading completion.

**[Note]** When a motor cord is updated, please turn OFF the amplifier power supply after data reading completion, then turn ON its power supply.

# 5. Basic Operation

## 5.2. Main Display

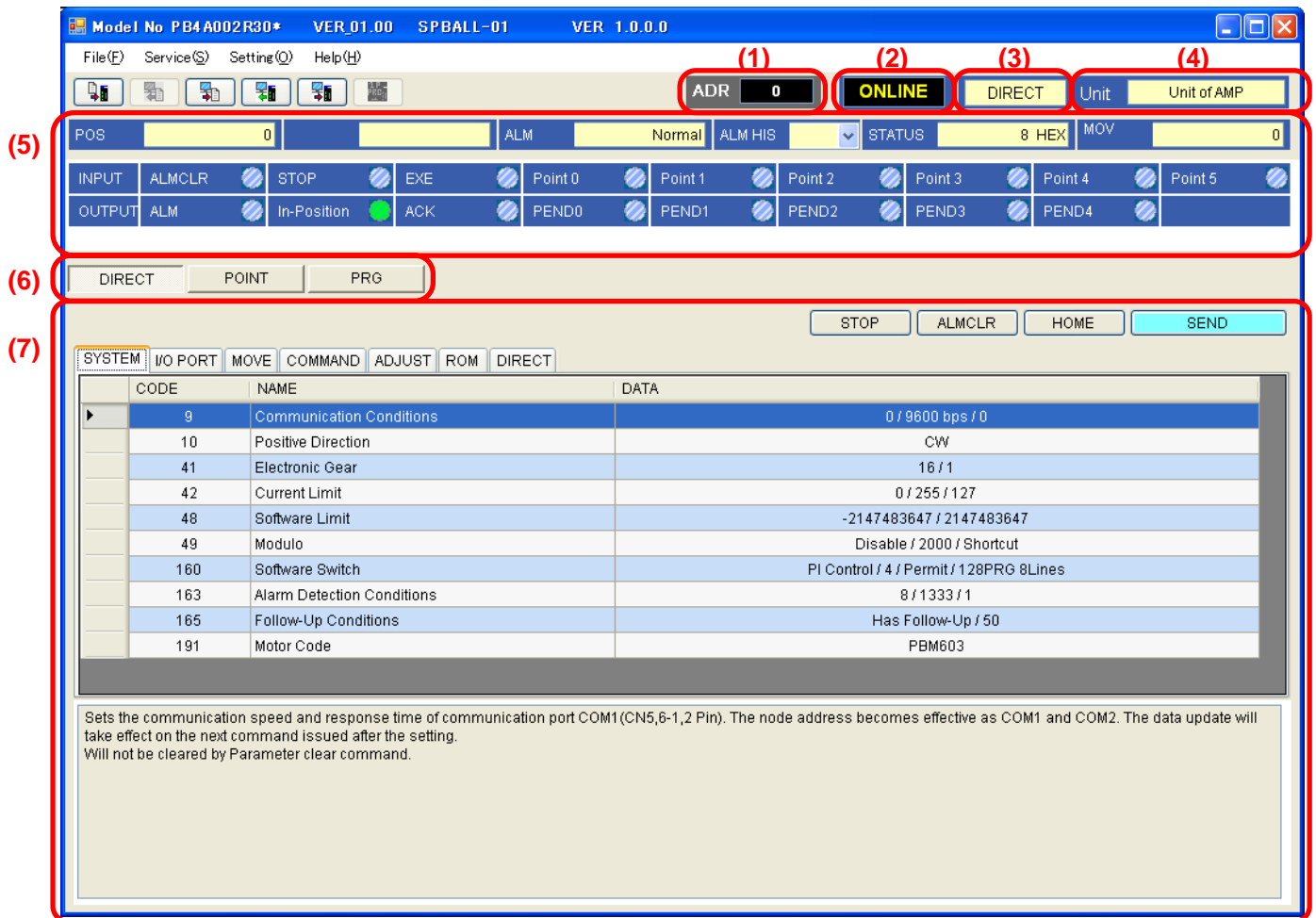



- (1) Amplifier Address            Indicates the address of the amplifier communicating.
- (2) State of Communication    Indicates the communicative state.
- (3) Mode Display                Indicates the current mode.
- (4) Unit System Display        Indicates the unit system setted-up.
- (5) Monitor Display            Indicates the states of the amplifier and I/O port.
- (6) Mode Selection Button     Changes the modes.(For the“PB4A002R30”)
- (7) Main Display                The displayed varies by the modes.

## 5. Basic Operation

### 5.3. Menu Bar/Tool Bar



#### ■ File(F)

File->PC		This loads the file data to the PC in one operation. The PC display is updated based on the file data.
PC->File		All data that is set on the current PC is saved to a file in one operation.
File->AMP		The selected file data is transferred and saved to the amplifier, and then a verify check is performed.
EXIT(X)		Closes "SPBALL-01"

#### ■ Service(S)

<PRG>: Valid with the Program Mode.

<R>: Only valid with the "PB4A002R30\*."

MODE <R>		A mode is changed.
Parameter clr		All parameters are initialized in the factory-shipments state.
ALLCLR		All parameters (including Point and PRG data for R type) in the amplifier are initialized.
AMP->PC		The amplifier data of the currently-selected mode is loaded to the PC.
PC->AMP		After the data of the currently-selected mode is sent to the amplifier, it is saved to the nonvolatile memory.
1PRG Save <R, PRG>		The data for the currently-selected PRG No. is saved to the amplifier. Valid with the Program Mode of the "PB4A002R."
SEND		Sends the currently-selected command.
START <R>		Starts-up the selected point or program.
STEP <R, PRG>		Executes one line of the program.
Program stop <R, PRG>		Stops the program.
STOP		Executes Emergency stop.
ALMCLR		Commands the alarm clear.

#### ■ Setting(O)

unit select		A unit system is selected. Refer to the Chap.5.6 for details.
monitor cycle		Selects the cycle of the monitor. Refer to the Chap.5.5 for details.
Numerical value		Either a decimal or hexadecimal number is selected for the notation system of command code designation.

#### ■ Help(H)

Version Information		Indicates the version information.
---------------------	--	------------------------------------

## 5. Basic Operation

### 5.4. Mode Selection Button

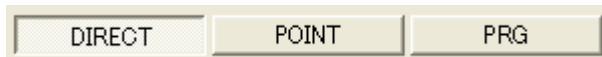

#### ■ Direct Mode

Executes the changes of an each parameter, and operation instruction, etc.

#### ■ Point Edit Mode (Only valid with the “PB4A002R30\*.”)

Executes the edition, setup, and filing of the point data.

#### ■ Program Edit Mode (Only valid with the “PB4A002R30\*.”)

Executes the edition, setup, debug, and filing of the program data.

### 5.5. Monitor

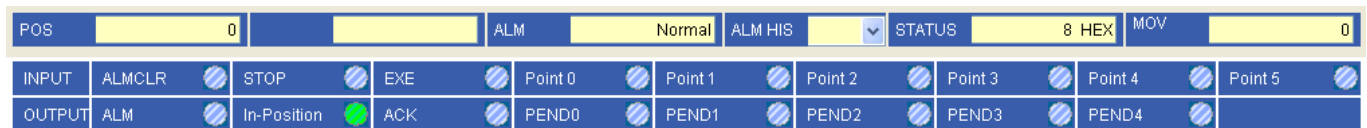

Indicates the current states of the amplifier and I/O port in real time

In addition, update cycle of monitoring can be changed by [Setting(O)]-[monitor cycle] on the menu bar.

POS	Indicates the absolute position counter inside amplifier.
CMDPOS	Indicates a train-of-impulses command counter. (Only valid with the “PB4A002P30*.”)
ALM	Indicates the current alarm state.
ALMHIS	Indicates the past alarm history.
STATUS	Indicates the current state of the amplifier. Refer to the amplifier’s instruction manual for details.
MOV	Indicates the completion factor of the motor drive. (Only valid with the “PB4A002R30*.”)
INPUT	Indicates the state of Input port.  =Non-Active  =Active
OUTPUT	Indicates the state of Output port.  =Non-Active  =Active

## 5. Basic Operation

---

### 5.6. Unit System

In SPBALL-01, the setting unit of travel distance, velocity, and the degree of acceleration and deceleration can be selected. Please select a unit system suitable for the mechanism to be used.

Please select liner type, a rotation system, or an amplifier unit from [Setting(O)]-[unit select] in the menu bar. Liner type sets up lead pitch and a rotation type sets up a deceleration ratio, respectively. Please input the value that applied the mechanical structure.

#### Unit System List

Unit System	Travel Distance	Velocity	Acceleration/Deceleration
Rotation type	Deg	min <sup>-1</sup>	ms (Time of acceleration/deceleration)
Liner type	mm	mm/sec	mm/sec <sup>2</sup>
Amplifier Unit	Pulse	min <sup>-1</sup>	min <sup>-1</sup> /ms

When the rotation/liner type is selected and setting is changed into an amplifier unit system, it being unable to be divided may occur. In this case, keep in mind that the display and the command value turn into a rounded-off value.

## 6. Direct Mode

### 6. Direct Mode

It is the mode that commands directly amplifier to change and operate a parameter.

#### 6.1. Direct Display

(1) The interface includes a top bar with function buttons: STOP, ALMCLR, HOME, and SEND.

(2) The command list table is as follows:

CODE	NAME	DATA
9	Communication Conditions	0 / 9600 bps / 0
10	Positive Direction	CW
41	Electronic Gear	16 / 1
42	Current Limit	0 / 255 / 127
48	Software Limit	-2147483647 / 2147483647
49	Modulo	Disable / 2000 / Shortcut
160	Software Switch	PI Control / 4 / Permit / 128PRG 8Lines
163	Alarm Detection Conditions	8 / 1333 / 1
165	Follow-Up Conditions	Has Follow-Up / 50
191	Motor Code	PBM603

(3) The summary text area contains the following information:

Sets the communication speed and response time of communication port COM1 (CN5,6-1,2 Pin). The node address becomes effective as COM1 and COM2. The data update will take effect on the next command issued after the setting.  
Will not be cleared by Parameter clear command.

(1) Function Button

The button assigned each function.

STOP: Changes Servo-on / servo-off.

ALMCLR: Commands an alarm to be cleared.

HOME: Commands a start-up of the Return to Zero.

SEND: Sends a selected command.

(2) Command List

Command list is indicated. The command is divided into the tab for every function.

(3) Summary

Explains of the selected commands are displayed.

## 6. Direct Mode

### 6.2. Operation Procedure

i. When you click a command to instruct it from the command list, turns into be blue and in a selective state.

- When changing the values;

If a cell is double-clicked, the dialog box for a parameter input will open. Go on to the ii.

- When not changing the value or in the case of a command without a parameter;

Go on to the iii.

(ex.) Select the In-Position Width (CODE;43).

SYSTEM	I/O PORT	MOVE	COMMAND	ADJUST	ROM	DIRECT
CODE	NAME	DATA				
38	ZONE1	1 / 0 / 0				
38	ZONE2	2 / 0 / 0				
38	ZONE3	3 / 0 / 0				
38	ZONE4	4 / 0 / 0				
39	Bit Out	127 / 127				
43	In-Position Width	16				
96	SELECT	Point				
161	Input/Output Port Logic	0 / 0 / 0 / 0				
162	Input/Output Port Functions	STOP / EXE / Point 0 / Point 1 / Point 2 / Point 3 / Point 4 / Point 5 / In-Position / ACK / PEND0 / ...				

ii. Input a value in the dialogue box to click [SET].

(ex.) Display for the In-Position Width input.

The screenshot shows a dialog box titled "I/O PORT" with a close button in the top right corner. The "Command" field is set to "43" and "In-Position Width". Below this, there is a text input field for "In-Position Width" containing the value "32" followed by "PLS". At the bottom of the dialog, there are two buttons: "SET" and "CANCEL".

iii. Click [SEND] to send the command.

SEND

## 6. Direct Mode

### 6.3. Direct Command Input

This is a function which communicates transceiver data with amplifier directly. Please use it, when you check transceiver data or send the command by which is not standard-supported.

Click [DIRECT] tab.

	DAT1	DAT2	DAT3	DAT4	DAT5	DAT6	DAT7	DAT8	DAT9	DAT10	DAT11	DAT12	DAT13	DAT14	DAT15	DAT16	DAT17	DAT18	DAT19	DAT20
Command	43																			
address	0																			
Data Input	16	0	0	0																
return value	4	0	5	9																

Set the value to be sent in [Command], [Address], and [Data Input], then click [SEND].

Sends the command and the received data will be displayed in [Return value].

#### Note

Input/Indication value can be turned decimal/HEX by [Setting(O)]-[Numerical value] in the menu bar.

## 7. Point Edit Mode

### 7. Point Edit Mode

The Point Function is a function to start the arbitrary commands previously stored in amplifier from an I/O Port or communication. In point edit mode, arbitrary commands can be stored in amplifier or the point can be started.

Only valid with "PB4A002R30\*."

#### 7.1. Point Edit Display

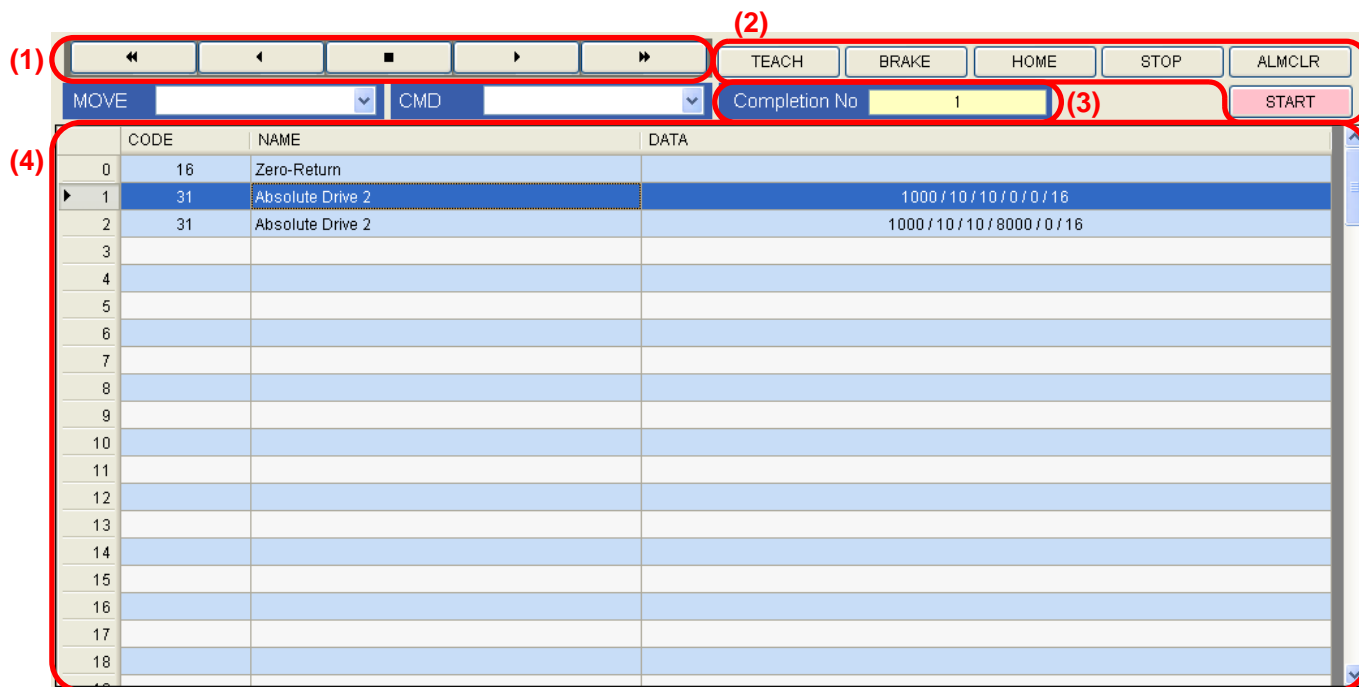

(1) Teaching Button

Teaching operation is performed.

(2) Function Button

It is the button which assigned each function.

TEACH: A current position is set as the point selected previously.

BRAKE: Brake holding / release at the time of servo-off is changed.

HOME: The zero return specified by Command 20h is started.

STOP: Servo-on / servo-off is changed.

ALMCLR: Alarm clear is instructed.

START: The selected point is started.

(3) Point Completion No.

The number of the point which completed on just before normaly is indicated.

(4) Point List

The list of point data is indicated.

# 7. Point Edit Mode

## 7.2. Point Edit Method

### ■ Operation Procedure

- i. The point number which performs edit is selected from a point list.  
When you click a point number, it turns into be blue and in a selective state.  
(ex.) Select the point Number 0.

	CODE	NAME	DATA
▶	0		
	1		
	2		
	3		
	4		
	5		
	6		
	7		

- ii. Select a command from the combo box.  
(ex.) Select the “Absolute Drive1”.

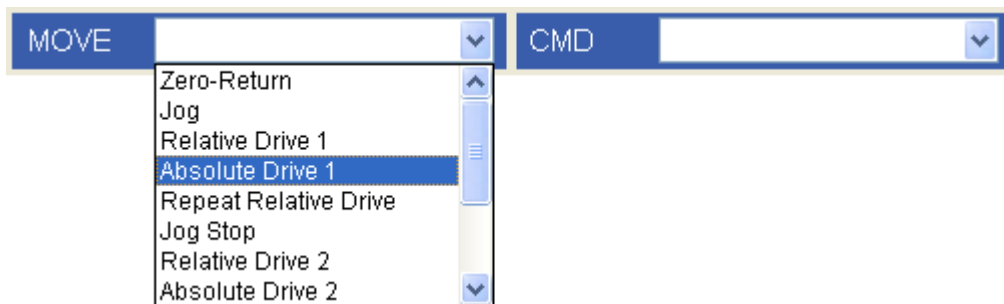

- MOVE: The command of a motor operation system
- CMD: The command of a parameter setting system

- iii. Input a value into the dialog box and click [SET].  
(ex.) Display of inputting the “Absolute Drive1.”



## 7. Point Edit Mode

iv. A command is set as a point list.

Furthermore, when setting up other points, repeat the procedure of (i) - (iii).

	CODE	NAME	DATA
▶ 0	19	Absolute Drive 1	8000
1			
2			
3			
4			
5			
6			
7			

v. If all the points finish setting up, point data will be transmitted to amplifier.

Click [Service(S)]-[PC->AMP] in the menu bar or  .

vi. When you start the point, please select the point number to start and click [START].



### ■ Pop Up Menu

If the point is selected; selection of two or more lines can be performed by dragging a mouse, and right-clicked, a pop up menu will be indicated.

COPY(C)	Ctrl+C
PASTE(P)	Ctrl+V
INSERT(I)	Ctrl+I
DELETE(D)	Ctrl+D



COPY	The selected point is copied. It can stick and do in [PASTE] and [INSERT].
PASTE	The [COPY] point is overwritten in the specified position.
INSERT	The [COPY] point is inserted in the specified position.
DELETE	Selected point data are deleted.

## 7. Point Edit Mode

### 7.3. Teaching

Teaching is the function to do jog operation of the motor and to set up a current position as point data.

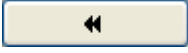
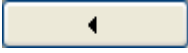
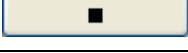
i. With a teaching button, a motor is operated and a position is decided.

	The negative direction jog operation. Conditions of operation follow command 21h setting conditions.
	Negative direction 1 step
	Jog stop
	Positive direction 1 step
	The positive direction jog operation. Conditions of operation follow command 21h setting conditions.

ii. Select the point number to set up.

	CODE	NAME	DATA
▶	0		
	1		
	2		
	3		
	4		
	5		
	6		
	7		

iii. If [TEACH] is clicked, it will be set as point data by considering a current position as the Absolute Drive 1.

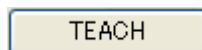

	CODE	NAME	DATA
▶	0	19 Absolute Drive 1	8000
	1		
	2		
	3		
	4		
	5		
	6		
	7		

iv. If all the points finish setting up, point data will be transmitted to amplifier.

Click [Service(S)]-[PC->AMP] in the menu bar or .

#### Note

Also in servo-off, since the current position at that time will be set as the point, if [TEACH] is clicked, the position of a motor can be decided by external force and the position can also be set as the point.

## 8. Program Edit Mode

### 8. Program Edit Mode

This program function is the function to start the arbitrary programs (continuation execution of a command) previously stored in amplifier from I/O or communication. In program edit mode, arbitrary programs can be stored in amplifier or a program can be started. Only valid with the "PB4A002R30\*."

Please refer to the 7.3rd clause, when you perform instruction by jog operation.

#### 8.1. Program Edit Display

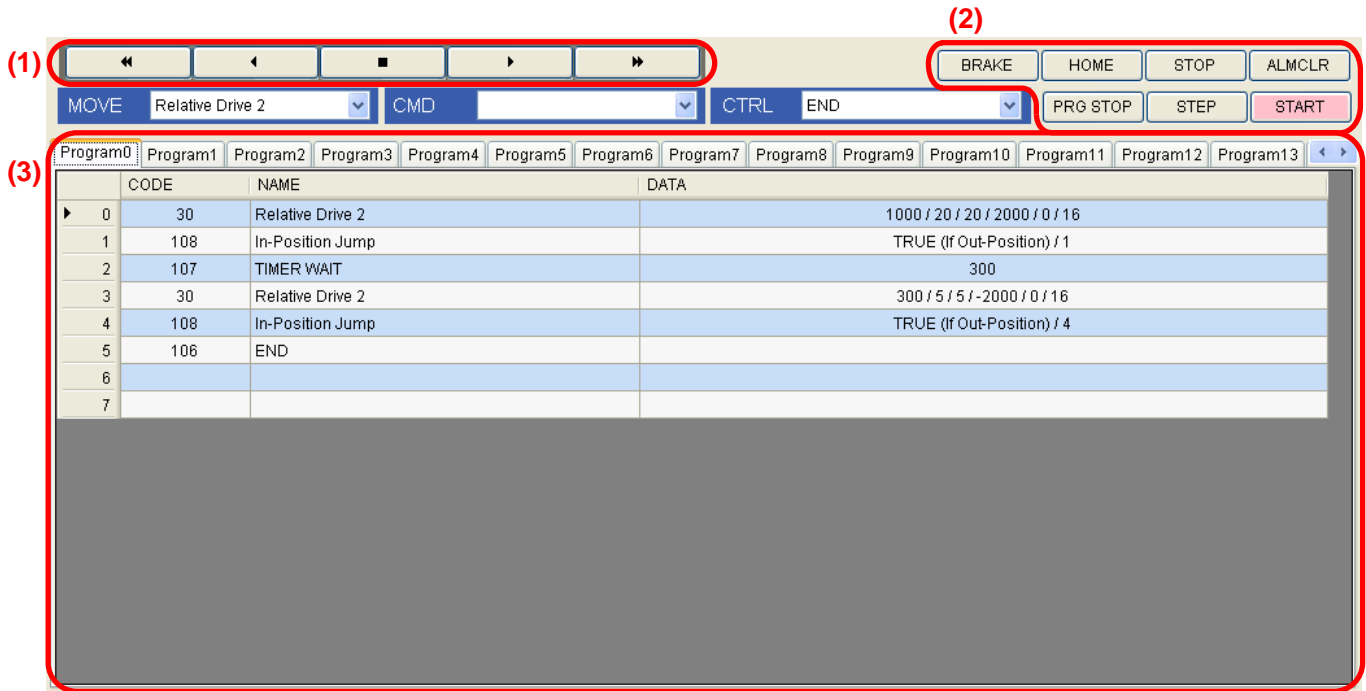

(1) Teaching button

Teaching operation is performed.

(2) Function button

It is the button which assigned each function.

BRAKE: Brake holding / release at the time of servo-off are changed.

HOME: The zero return specified by Command 20h is started.

STOP: Servo-on / servo-off is changed.

ALMCLR: Alarm clear is instructed.

PRG STOP: The program under execution is stopped.

STEP: Executes a program one line at a time.

START The program currently indicated is executed.

(3) Program List

The list of point data is indicated.

## 8. Program Edit Mode

### 8.2. Program Edit Method

Please select the number of programs previously by the softwareswitch of a direct command.

#### ■ Operation Procedure

- i. Select the program line which performs edit from a program list.

If a line is clicked, turns into be blue and in a selective state.

	CODE	NAME	DATA
▶	0		
	1		
	2		
	3		
	4		
	5		
	6		
	7		

- ii. Select a command from the combo box.

(ex.) Select the "FOR."



MOVE: The command of a motor operation system

CMD: The command of a parameter setting system

CTRL: Programmed control sentence

- iii. Input a value into the dialog box and click [SET].

(ex.) Display of inputting the "FOR".



## 8. Program Edit Mode

iv. The command is set as a program.

Furthermore, when setting up other lines, repeat the procedure of i - iii.

	CODE	NAME	DATA
▶ 0	113	FOR	1 / 10
1			
2			
3			
4			
5			
6			
7			

v. If all the lines finish setting up, a program will be transmitted to amplifier.

- When you transmit only the program currently indicated;

Click [Service(S)]-[1PRG Save] in the menu bar or .

- When you transmit the all programs in one operation;

Click [Service(S)]-[PC->AMP] in the menu bar or .

### ■ Pop Up Menu

If the point is selected; selection of two or more lines can be performed by dragging a mouse, and right-clicked, a pop up menu will be indicated.

COPY(C)	Ctrl+C
PASTE(P)	Ctrl+V
INSERT(I)	Ctrl+I
DELETE(D)	Ctrl+D

COPY	The selected line is copied. It can stick and do in [PASTE] and [INSERT].
PASTE	The [COPY] line is overwritten in the specified position.
INSERT	The [COPY] line is inserted in the specified position.
DELETE	The selected line is deleted.

\*Refer to the amplifier instructions manual for the details of each command function.

## 8. Program Edit Mode

### 8.3. Program Execution

When the program to execute is indicated, click [START] to execute a program.

The program will be started.



When you stop the program under execution, click [PRG STOP].

The program will be stopped.

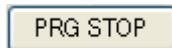

When performing operation checking of a program, the [STEP] button can perform stepwise execution. The selected line of one line will be performed. If one line is performed and completed execution at a time, whenever click [STEP] button, the following line will be selected automatically.

Please do not start stepwise execution from the command in the range specified by [FOR] - [NEXT] loop, or a subroutine.

Select the line which starts stepwise execution.

	CODE	NAME	DATA
▶ 0	30	Relative Drive 2	1000 / 20 / 20 / 2000 / 0 / 16
1	108	In-Position Jump	TRUE (if Out-Position) / 1
2	107	TIMER WAIT	300
3	30	Relative Drive 2	300 / 5 / 5 / -2000 / 0 / 16
4	108	In-Position Jump	TRUE (if Out-Position) / 4
5	106	END	
6			
7			

A click of [STEP] executes the selected line, and will be selected the next one automatically.

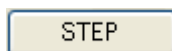

	CODE	NAME	DATA
0	30	Relative Drive 2	1000 / 20 / 20 / 2000 / 0 / 16
▶ 1	108	In-Position Jump	TRUE (if Out-Position) / 1
2	107	TIMER WAIT	300
3	30	Relative Drive 2	300 / 5 / 5 / -2000 / 0 / 16
4	108	In-Position Jump	TRUE (if Out-Position) / 4
5	106	END	
6			
7			

\*Refer to the amplifier instructions manual for the procedure of executing a program by I/O.

## 8. Program Edit Mode

### 8.4. Sample Program

This program is a program that moves 2000 pulses to the positive direction at the first, and moves to the negative direction 2000 pulses after passing 300ms.

	CODE	NAME	DATA
▶ 0	30	Relative Drive 2	1000 / 20 / 20 / 2000 / 0 / 16
1	108	In-Position Jump	TRUE (if Out-Position) / 1
2	107	TIMER WAIT	300
3	30	Relative Drive 2	300 / 5 / 5 / -2000 / 0 / 16
4	108	In-Position Jump	TRUE (if Out-Position) / 4
5	106	END	
6			
7			

#### Command Description

Line	Command	Description
0	Relative Drive 1	Moves 2000 pulse with speed $1000\text{min}^{-1}$ , acceleration $20\text{min}^{-1}/\text{ms}$ , and decelerating $20\text{min}^{-1}/\text{ms}$ .
1	In-Position JMP	Completion waiting of a move command of the 0th line of operation. (*1) This line is repeated and performed until an in position signal is set to ON.
2	TIMER WAIT	Timer wait: 300ms
3	Relative Drive 2	Moves -2000 pulse with speed $300\text{min}^{-1}$ , acceleration $5\text{min}^{-1}/\text{ms}$ , and decelerating $5\text{min}^{-1}/\text{ms}$ .
4	In-Position JMP	Completion waiting of a move command of the 3rd line of operation. This line is repeated and performed until an in position signal is set to ON.
5	END	Program END

(\*1) When not putting in waiting for completion of operation, the command of the next line is executed in the state of un-[ of operation ] completing. Besides, when the command after an operation command is END, a program state is ended while it has been an operating state.

(ex.) In the case of the program of operation command +END

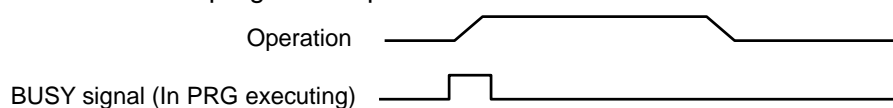

In the case of the program of waiting for the completion of operation command + operation +END

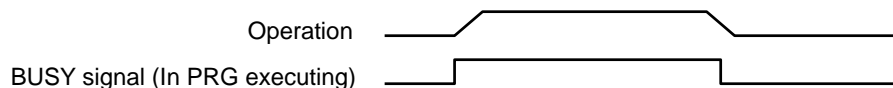

The waveform of operation at the time of executing this program is as follows.

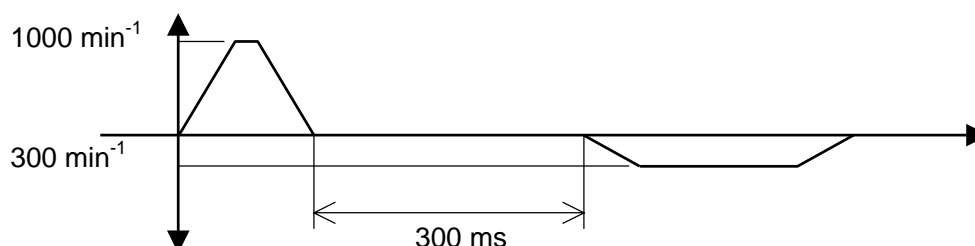

## 9. Waveform Trace

### 9. Waveform Trace

Velocity, Position deviation, Current command, and the waveform monitor of I/O Port can be performed. Click [Service(S)]-[MODE]-[WAVEFORM] in the menu bar to start-up.

#### 9.1. Waveform Trace Display

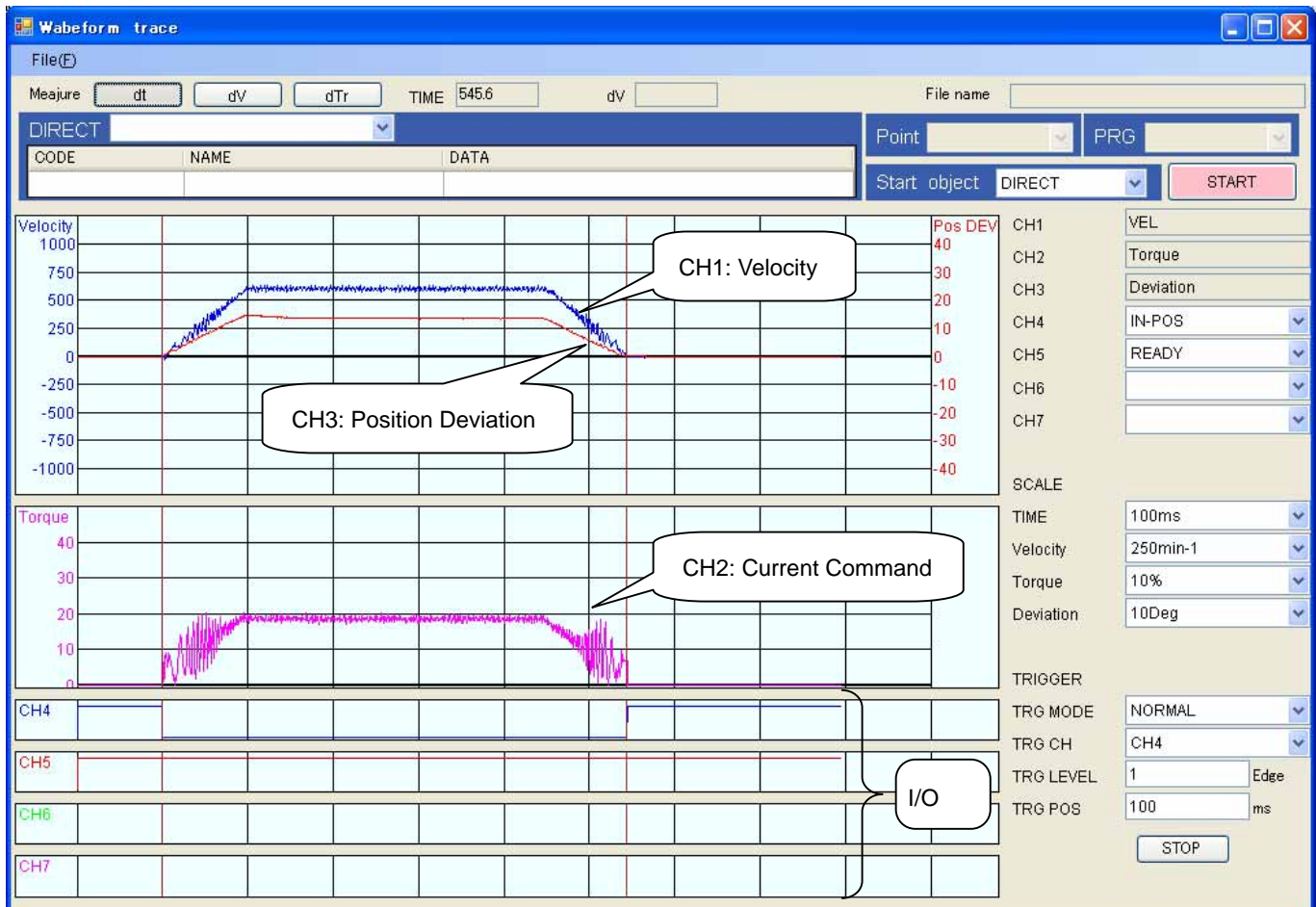

**Note** The position deviation can be measured with only train-of-impulses command type amplifier.

**Note** Velocity waveform includes error around  $\pm 30\text{min}^{-1}$  by sampling error.

## 9. Waveform Trace

### 9.2. Waveform Trace Operation Procedure

- i. The Velocity (CH1), the Current command (CH2), and the Position deviation (CH3) cannot be changed because these are fixed. When you monitor an I/O Port, please set it at CH4-CH7. The I/O Port can be simultaneously monitored to four.

CH1	VEL
CH2	Torque
CH3	Deviation
CH4	IN-POS
CH5	READY
CH6	
CH7	

- ii. Select the SCALE of monitoring display. The set point is a value per 1 div.

SCALE	
TIME	100ms
Velocity	250min <sup>-1</sup>
Torque	10%
Deviation	10Deg

- iii. Set the TRIGGER conditions.

TRIGGER	
TRG MODE	NORMAL
TRG CH	CH4
TRG LEVEL	1 Edge
DELAY Time	100 ms

TRG MODE	AUTO	The current state is indicated by free run.
	NORMAL	The display is rewritten whenever the Trigger is detected.
	SINGLE	The Trigger is detected once, it will stop sampling.
TRG CH		The object channel of the Trigger is set up.
TRG LEVEL		The edge when making an I/O Port into the Trigger is selected. 0: Start edge 1: Fall edge
DELAY Time		The Trigger Position (Delay time) is set.

## 9. Waveform Trace

---

- iv. Click [RUN] to start sampling.

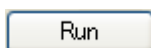

- v. During sampling, the display of [RUN] button changes to [STOP].  
Click [STOP] to stop sampling.



After the trigger is detected, the button will be displayed "Active."



### Note

Trigger conditions cannot be changed during sampling. When you change the conditions, please do it in the state that sampling is stopped.

# 9. Waveform Trace

## 9.3. Measure

Meajure    TIME  dV

The measure is a function that can perform a waveform check. There are three kinds of measure as the following, and when you click the button to measure, the (brown) cursor will be appeared on the display. The cursor is indicated on the position of "0" at the first time. Waveform can be measured by dragging cursor with a mouse.

<input type="button" value="dt"/>	Time measure
<input type="button" value="dV"/>	Velocity measure
<input type="button" value="dV"/>	Current command measure

Please drag the measure and specify measuring range.

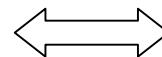
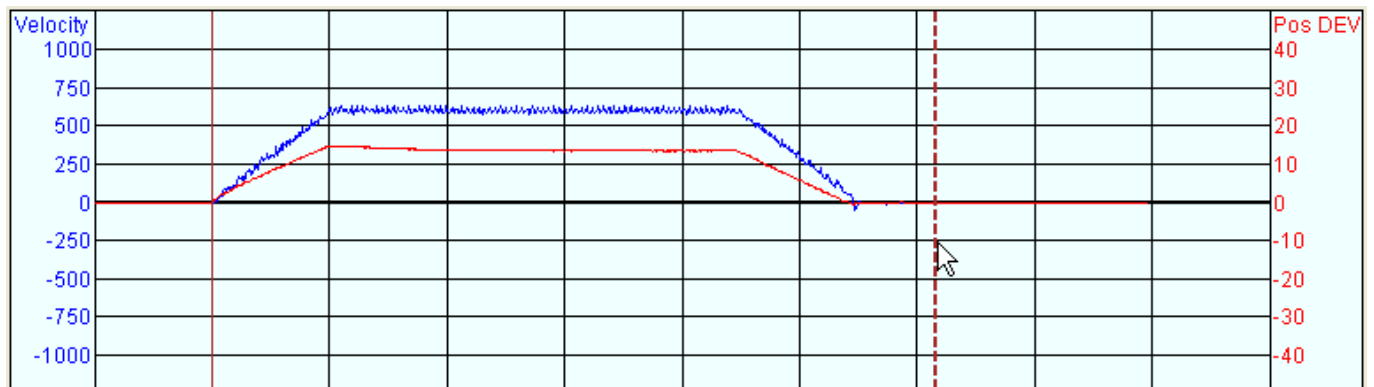

## 9. Waveform Trace

### 9.4. Motor Starting-up during Waveform Trace

DIRECT <input type="text" value="Relative Drive 2"/>			Point <input type="text" value="5"/>	PRG <input type="text" value="0"/>
CODE	NAME	DATA	Start object <input type="text" value="DIRECT"/>	
30	Relative Drive 2	1000 / 10 / 10 / 8000 / 0 / 16	<input type="button" value="START"/>	

With the waveform trace display, amplifier can be instructed by the operation command, the point start-up, and the program start-up in the DIRECT mode.

A command to instruct the amplifier is set-up.

<input type="text" value="Start object"/> <input type="text" value="DIRECT"/>	The kind of command to instruct is selected. DIRECT: Operation command POINT: Point start-up PRG: Program start-up
<input type="text" value="DIRECT"/> <input type="text" value="Relative Drive 2"/>	The command of operation at selecting [DIRECT] as the Start Object is specified.
<input type="text" value="Point"/> <input type="text" value="5"/>	The point number at selecting [POINT] as the Start Object is specified.
<input type="text" value="PRG"/> <input type="text" value="0"/>	The program number at selecting [PRG] as the Start Object is specified.

Click [START] to send the set-up command.



## Precautions For Adoption

### **Cautions**

The possibility of moderate or minor injury and the occurrence of physical damage are assumed when the precautions at right column are not observed. Depending on the situation, this may cause serious consequences. Be sure to follow all listed precautions.

### **Cautions**

- Be sure to read the instruction manual before using this product.
- Take sufficient safety measures and contact us before applying this product to medical equipment that may involve human lives.
- Contact us before adapting this product for use with equipment that could cause serious social or public effects.
- The use of this product in high motion environments where vibration is present, such as in vehicles or shipping vessels, is prohibited.
- Do not convert or modify any equipment components.

\* Please contact our Business Division for questions and consultations regarding the above.

<http://www.sanyodenki.co.jp>

#### **SANYO DENKI CO., LTD.**

1-15-1, Kita-Otsuka, Toshima-ku, Tokyo 170-8451, Japan

Phone: +81 3 3917 5157

#### **SANYO DENKI AMERICA, INC.**

468 Amapola Avenue Torrance, CA 90501 U.S.A.

Phone: +1 310 783 5400

#### **SANYO DENKI EUROPE SA.**

P.A. Paris Nord II 48 Allee des Erables-VILLEPINTE BP.57286 F-95958 ROISSY CDG Cedex France

Phone: +33 1 48 63 26 61

#### **SANYO DENKI GERMANY GmbH**

Frankfurter Strasse 63-69 65760 Eschborn Germany

Phone: +49 6196 76113 0

#### **SANYO DENKI KOREA CO., LTD.**

9F 5-2, Sunwha-dong Jung-gu Seoul, 100-130, Korea

Phone: +82 2 773 5623

#### **SANYO DENKI SHANGHAI CO., LTD.**

Room 2116, Bldg B, FAR EAST INTERNATIONAL PLAZA, No.317 XianXia Rd., Shanghai 200051 China

Phone: +86 21 6235 1107

#### **SANYO DENKI TAIWAN CO., LTD.**

Room 1208,12F, No.96 Chung Shan N, Rd., Sec.2, Taipei 104, Taiwan, R.O.C.

Phone: +886 2 2511 3938

#### **SANYO DENKI (H.K.) CO., LIMITED**

Room 2305, 23/F, South Tower, Concordia Plaza, 1 Science Museum Rd., TST East, Kowloon, Hong Kong

Phone: +852 2312 6250

#### **SANYO DENKI SINGAPORE PTE. LTD.**

10 Hoe Chiang Road #14-03A/04 Keppel Towers Singapore 089315

Phone: +65 6223 1071

The names of companies and/or their products specified in this manual are the trade names, and/or trademarks and/or registered trademarks of such respective companies.

\*Remarks : Specifications Are Subject To Change Without Notice.